



 **TERÄTOIMITUS**.fi

Kovametallijyrsimet komposiitin työstöön



KOMPOSIITTIYRSIMET

Kovametalli pyörövilat ristileikkuulla
Lasikuidulle, epoksihartsille hiilikuidulle
Saatavana DLC –pinnoitteella (timanttipinnoite)

TERÄTOIMITUS.fi



Typ XN Hieno hammastus

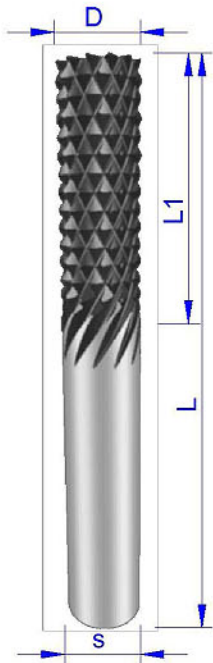

D	L1	L	s	Z	Art.. Nr	Art.. Nr
3	10	40	3		XN.030.010.040	XN.030.010.040.DLC
4	15	40	4		XN.040.015.040	XN.040.015.040.DLC
4	15	60	4		XN.040.015.060	XN.040.015.060.DLC
5	16	50	5		XN.050.016.050	XN.050.016.050.DLC
6	18	55	6		XN.060.018.055	XN.060.018.055.DLC
6	18	70	6		XN.060.018.070	XN.060.018.070.DLC
8	22	60	8		XN.080.022.060	XN.080.022.060.DLC
8	25	80	8		XN.080.025.080	XN.080.025.080.DLC
10	25	80	10		XN.100.025.080	XN.100.025.080.DLC
10	30	90	10		XN.100.030.090	XN.100.030.090.DLC
12	30	90	12		XN.120.030.090	XN.120.030.090.DLC
12	35	100	12		XN.120.035.100	XN.120.035.100.DLC
14	35	90	12		XN.140.035.090	XN.140.035.090.DLC
14	40	100	12		XN.140.040.100	XN.140.040.100.DLC

Typ XM Karkea hammastus

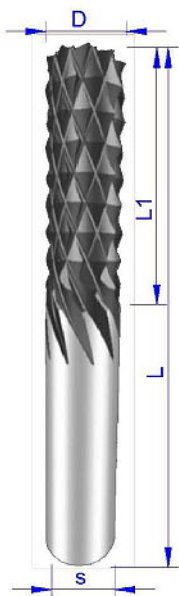
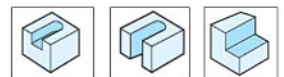

D	L1	L	s	Z	Art.. Nr	Art.. Nr
3	10	40	3		XM.030.010.040	XM.030.010.040.DLC
4	15	40	4		XM.040.015.040	XM.040.015.040.DLC
4	15	60	4		XM.040.015.060	XM.040.015.060.DLC
5	16	50	5		XM.050.016.050	XM.050.016.050.DLC
6	18	55	6		XM.060.018.055	XM.060.018.055.DLC
6	18	70	6		XM.060.018.070	XM.060.018.070.DLC
8	22	60	8		XM.080.022.060	XM.080.022.060.DLC
8	25	80	8		XM.080.025.080	XM.080.025.080.DLC
10	25	80	10		XM.100.025.080	XM.100.025.080.DLC
10	30	90	10		XM.100.030.090	XM.100.030.090.DLC
12	30	90	12		XM.120.030.090	XM.120.030.090.DLC
12	35	100	12		XM.120.035.100	XM.120.035.100.DLC
14	35	90	12		XM.140.035.090	XM.140.035.090.DLC
14	40	100	12		XM.140.040.100	XM.140.040.100.DLC



Medium hammastus Typ XC

D	L1	L	s	Z	Art.. Nr		Art.. Nr
4	10	40	4		XC.040.010.040		XC.040.010.040.DLC
4	15	60	4		XC.040.015.060		XC.040.015.060.DLC
5	16	50	5		XC.050.016.050		XC.050.016.050.DLC
6	18	55	6		XC.060.018.055		XC.060.018.055.DLC
6	18	70	6		XC.060.018.070		XC.060.018.070.DLC
8	22	60	8		XC.080.022.060		XC.080.022.060.DLC
8	25	80	8		XC.080.025.080		XC.080.025.080.DLC
10	25	80	10		XC.100.025.080		XC.100.025.080.DLC
10	30	90	10		XC.100.030.090		XN.100.030.090.DLC
12	30	90	12		XC.120.030.090		XC.120.030.090.DLC
12	35	100	12		XC.120.035.100		XC.120.035.100.DLC
14	35	90	12		XC.140.035.090		XC.140.035.090.DLC
14	40	100	12		XC.140.040.100		XC.140.040.100.DLC

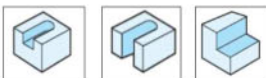
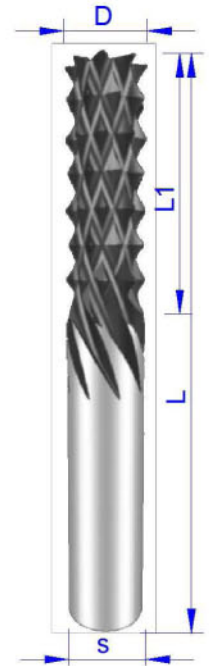

Hieno hammastus – suora leikkuu Typ XNV

D	L1	L	s	Z	Art.. Nr		Art.. Nr
6	18	55	6		XNV.060.018.055		XNV.060.018.055.DLC
6	18	70	6		XNV.060.018.070		XNV.060.018.070.DLC
8	22	60	8		XNV.080.022.060		XNV.080.022.060.DLC
8	25	80	8		XNV.080.025.080		XNV.080.025.080.DLC
10	25	80	10		XNV.100.025.080		XNV.100.025.080.DLC
10	30	90	10		XNV.100.030.090		XNV.100.030.090.DLC
12	30	90	12		XNV.120.030.090		XNV.120.030.090.DLC
12	35	100	12		XN.120.035.100		XN.120.035.100.DLC
14	35	90	12		XN.140.035.090		XN.140.035.090.DLC
14	40	100	12		XN.140.040.100		XN.140.040.100.DLC

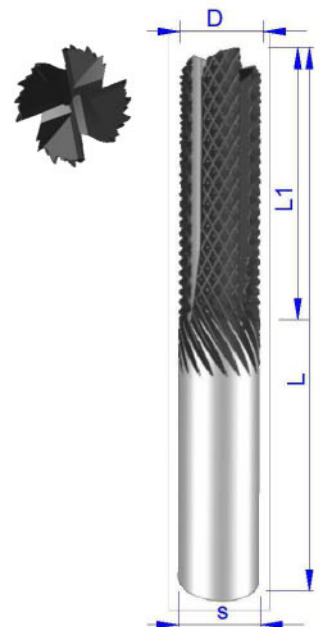

Lasikuidulle, hiilikuidulle, kennolevylle
 Saatavana DLC –pinnoitteella (timanttipinnoite)

Typ VN Alaspäin painava leikkuu

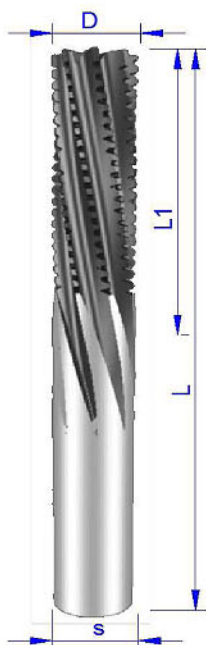
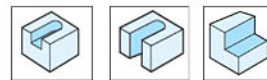

D	L1	L	s	Art.. Nr	Art.. Nr	Art.. Nr
6	15	60	6	VN.060.015.060	VN.060.015.060.DLC	
6	20	70	6	VN.060.020.070	VN.060.020.070.DLC	
8	20	60	8	VN.080.020.060	VN.080.020.060.DLC	
8	25	80	8	VN.080.025.080	VN.080.025.080.DLC	
10	25	80	10	VN.100.025.080	VN.100.025.080.DLC	
10	30	90	10	VN.100.030.090	VN.100.030.090.DLC	
12	30	90	12	VN.120.030.090	VN.120.030.090.DLC	
12	35	100	12	VN.120.035.100	VN.120.035.100.DLC	
14	35	90	12	VN.140.035.090	VN.140.035.090.DLC	
14	40	100	12	VN.140.040.100	VN.140.040.100.DLC	
16	35	90	12	VN.160.035.090	VN.160.035.090.DLC	
16	40	100	12	VN.160.040.100	VN.160.040.100.DLC	

Typ VP Ylöspäin nostava leikkuu

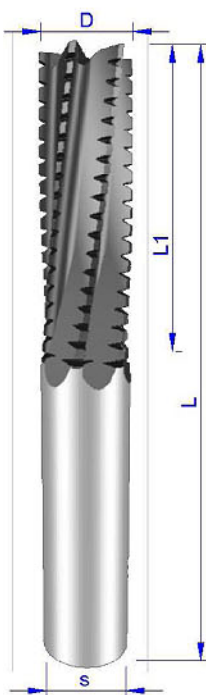
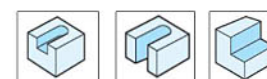

D	L1	L	s	Art.. Nr	Art.. Nr	Art.. Nr
6	15	60	6	VP.060.015.060	VP.060.015.060.DLC	
6	20	70	6	VP.060.020.070	VP.060.020.070.DLC	
8	20	70	8	VP.070.022.060	VP.070.022.060.DLC	
8	25	80	8	VP.080.025.080	VP.080.025.080.DLC	
10	25	80	10	VP.100.025.080	VP.100.025.080.DLC	
10	30	90	10	VP.100.030.090	VP.100.030.090.DLC	
12	30	90	12	VP.120.030.090	VP.120.030.090.DLC	
12	35	100	12	VP.120.035.100	VP.120.035.100.DLC	
14	35	90	12	VP.140.035.090	VP.140.035.090.DLC	
14	40	100	12	VP.140.040.100	VP.140.040.100.DLC	
16	35	90	12	VP.160.035.090	VP.160.035.090.DLC	
16	40	100	12	VP.160.040.100	VP.160.040.100.DLC	

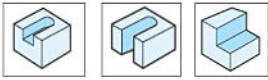

Suora Leikkuu Typ VS

D	L1	L	s	Art.. Nr	Art.. Nr
6	15	60	6	VS.060.015.060	VS.060.015.060.DLC
6	20	70	6	VS.060.020.070	VS.060.020.070.DLC
8	20	60	8	VS.080.020.060	VS.080.020.060.DLC
8	25	80	8	VS.080.025.080	VS.080.025.080.DLC
10	25	80	10	VS.100.025.080	VS.100.025.080.DLC
10	30	90	10	VS.100.030.090	VS.100.030.090.DLC
12	30	90	12	VS.120.030.090	VS.120.030.090.DLC
12	35	100	12	VS.120.035.100	VS.120.035.100.DLC
14	35	90	12	VS.140.035.090	VS.140.035.090.DLC
14	40	100	12	VS.140.040.100	VS.140.040.100.DLC
16	35	90	12	VS.160.035.090	VS.160.035.090.DLC
16	40	100	12	VS.160.040.100	VS.160.040.100.DLC

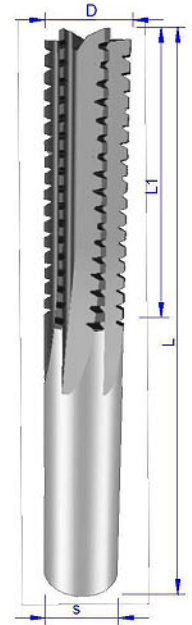

Ylöspäin nostava leikkuu päätypyörityksellä Typ VPR

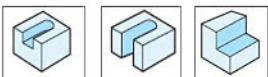

D	L1	L	s	Art.. Nr	Art.. Nr
6	15	60	6	VPR.060.015.060	VPR.060.015.060.DLC
6	20	70	6	VPR.060.020.070	VPR.060.020.070.DLC
8	20	60	8	VPR.080.020.060	VPR.080.020.060.DLC
8	25	80	8	VPR.080.025.080	VPR.080.025.080.DLC
10	25	80	10	VPR.100.025.080	VPR.100.025.080.DLC
10	30	90	10	VPR.100.030.090	VPR.100.030.090.DLC
12	30	90	12	VPR.120.030.090	VPR.120.030.090.DLC
12	35	100	12	VPR.120.035.100	VPR.120.035.100.DLC
14	35	90	12	VPR.140.035.090	VPR.140.035.090.DLC
14	40	100	12	VPR.140.040.100	VPR.140.040.100.DLC
16	35	90	12	VPR.160.035.090	VPR.160.035.090.DLC
16	40	100	12	VPR.160.040.100	VPR.160.040.100.DLC

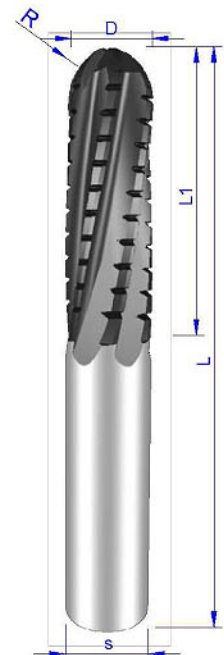

Lasikuidulle, hiilikuidulle, kennolevylle
 Saatavana DLC –pinnoitteella (timanttipinnoite)

**Typ TWC Ylöspäin nostava /
 alaspäin painava leikkuu**

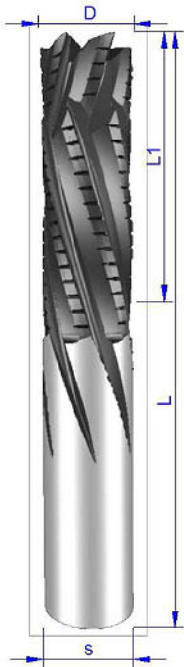

D	L1	L	s	Art.. Nr	Art.. Nr
6	15	60	6	TWC.060.015.060	TWC.060.015.060.DLC
6	20	70	6	TWC.060.020.070	TWC.060.020.070.DLC
8	20	60	8	TWC.080.020.060	TWC.080.020.060.DLC
8	25	80	8	TWC.080.025.080	TWC.080.025.080.DLC
10	25	80	10	TWC.100.025.080	TWC.100.025.080.DLC
10	30	90	10	TWC.100.030.090	TWC.100.030.090.DLC
12	30	90	12	TWC.120.030.090	TWC.120.030.090.DLC
12	35	100	12	TWC.120.035.100	TWC.120.035.100.DLC
14	35	90	12	TWC.140.035.090	TWC.140.035.090.DLC
14	40	100	12	TWC.140.040.100	TWC.140.040.100.DLC
16	35	90	12	TWC.160.035.090	TWC.160.035.090.DLC
16	40	100	12	TWC.160.040.100	TWC.160.040.100.DLC

KOMPOSIITTIJYRSIMET

Kovametalliviimeistely jyrsimet
 Lasikuidulle, hiilikuidulle, kennolevylle
 Saatavana DLC –pinnoitteella (timanttipinnoite)

**Typ TWG Ylöspäin nostava /
 alaspäin painava leikkuu**

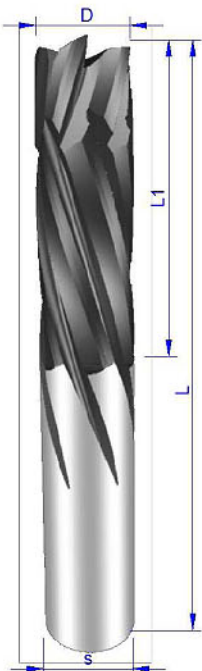
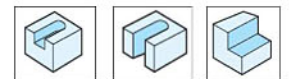

D	L1	L	s	Art.. Nr	Art.. Nr
6	15	60	6	TWG.060.015.060	TWG.060.015.060.DLC
6	20	70	6	TWG.060.020.070	TWG.060.020.070.DLC
8	20	60	8	TWG.080.020.060	TWG.080.020.060.DLC
8	25	80	8	TWG.080.025.080	TWG.080.025.080.DLC
10	25	80	10	TWG.100.025.080	TWG.100.025.080.DLC
10	30	90	10	TWG.100.030.090	TWG.100.030.090.DLC
12	30	90	12	TWG.120.030.090	TWG.120.030.090.DLC
12	35	100	12	TWG.120.035.100	TWG.120.035.100.DLC
14	35	90	12	TWG.140.035.090	TWG.140.035.090.DLC
14	40	100	12	TWG.140.040.100	TWG.140.040.100.DLC
16	35	90	12	TWG.160.035.090	TWG.160.035.090.DLC
16	40	100	12	TWG.160.040.100	TWG.160.040.100.DLC

Typ GN Alaspäin painava leikkuu

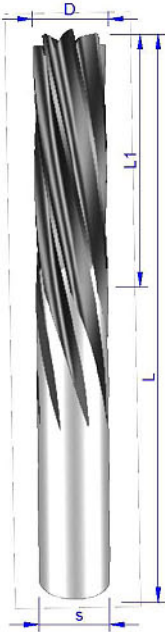

D	L1	L	s	Art.. Nr		Art.. Nr	
6	15	60	6	GN.060.015.060		GN.060.015.060.DLC	
6	20	70	6	GN.060.020.070		GN.060.020.070.DLC	
8	20	60	8	GN.080.020.060		GN.080.020.060.DLC	
8	25	80	8	GN.080.025.080		GN.080.025.080.DLC	
10	25	80	10	GN.100.025.080		GN.100.025.080.DLC	
10	30	90	10	GN.100.030.090		GN.100.030.090.DLC	
12	30	90	12	GN.120.030.090		GN.120.030.090.DLC	
12	35	100	12	GN.120.035.100		GN.120.035.100.DLC	
14	35	90	12	GN.140.035.090		GN.140.035.090.DLC	
14	40	100	12	GN.140.040.100		GN.140.040.100.DLC	
16	35	90	12	GN.160.035.090		GN.160.035.090.DLC	
16	40	100	12	GN.160.040.100		GN.160.040.100.DLC	

Typ GP Ylöspäin nostava leikkuu

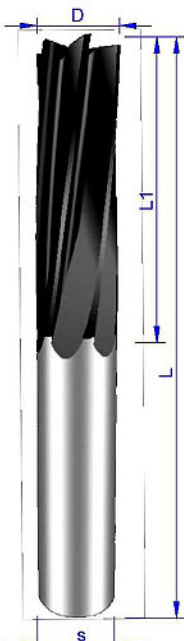
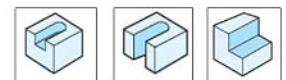

D	L1	L	s	Art.. Nr		Art.. Nr	
6	15	60	6	GP.060.015.060		GP.060.015.060.DLC	
6	20	70	6	GP.060.020.070		GP.060.020.070.DLC	
8	20	70	8	GP.070.022.060		GP.070.022.060.DLC	
8	25	80	8	GP.080.025.080		GP.080.025.080.DLC	
10	25	80	10	GP.100.025.080		GP.100.025.080.DLC	
10	30	90	10	GP.100.030.090		GP.100.030.090.DLC	
12	30	90	12	GP.120.030.090		GP.120.030.090.DLC	
12	35	100	12	GP.120.035.100		GP.120.035.100.DLC	
14	35	90	12	GP.140.035.090		GP.140.035.090.DLC	
14	40	100	12	GP.140.040.100		GP.140.040.100.DLC	
16	35	90	12	GP.160.035.090		GP.160.035.090.DLC	
16	40	100	12	GP.160.040.100		GP.160.040.100.DLC	



Suora leikkuu Typ GS

D	L1	L	s	Art.. Nr		Art.. Nr	
6	15	60	6	GS.060.015.060		GS.060.015.060.DLC	
6	20	70	6	GS.060.020.070		GS.060.020.070.DLC	
8	20	60	8	GS.080.020.060		GS.080.020.060.DLC	
8	25	80	8	GS.080.025.080		GS.080.025.080.DLC	
10	25	80	10	GS.100.025.080		GS.100.025.080.DLC	
10	30	90	10	GS.100.030.090		GS.100.030.090.DLC	
12	30	90	12	GS.120.030.090		GS.120.030.090.DLC	
12	35	100	12	GS.120.035.100		GS.120.035.100.DLC	
14	35	90	12	GS.140.035.090		GS.140.035.090.DLC	
14	40	100	12	GS.140.040.100		GS.140.040.100.DLC	
16	35	90	12	GS.160.035.090		GS.160.035.090.DLC	
16	40	100	12	GS.160.040.100		GS.160.040.100.DLC	

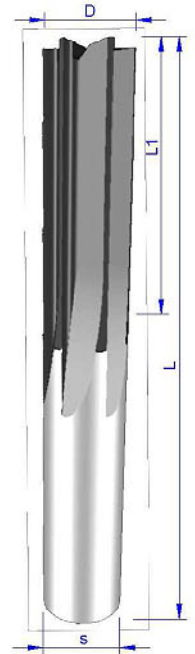

Ylöspäin nostava leikkuu päätypyörityksellä Typ GPR

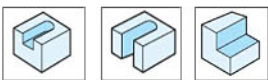

D	L1	L	s	Art.. Nr		Art.. Nr	
6	15	60	6	GPR.060.015.060		GPR.060.015.060.DLC	
6	20	70	6	GPR.060.020.070		GPR.060.020.070.DLC	
8	20	60	8	GPR.080.020.060		GPR.080.020.060.DLC	
8	25	80	8	GPR.080.025.080		GPR.080.025.080.DLC	
10	25	80	10	GPR.100.025.080		GPR.100.025.080.DLC	
10	30	90	10	GPR.100.030.090		GPR.100.030.090.DLC	
12	30	90	12	GPR.120.030.090		GPR.120.030.090.DLC	
12	35	100	12	GPR.120.035.100		GPR.120.035.100.DLC	
14	35	90	12	GPR.140.035.090		GPR.140.035.090.DLC	
14	40	100	12	GPR.140.040.100		GPR.140.040.100.DLC	
16	35	90	12	GPR.160.035.090		GPR.160.035.090.DLC	
16	40	100	12	GPR.160.040.100		GPR.160.040.100.DLC	

