



# XTREME COATING

## THE ULTIMATE TECHNOLOGY FOR INDUSTRIAL CNC TOOLS

DLCS is a modified diamond-like carbon coating with superior load bearing capacity. This hard, durable metal-based finish (chromium nitride) provides an higher hardness surface and enhances the tribological properties of the carbon coating. Its application prevents excessive heat build up which is detrimental to performance. This means cutting tools remain fully effective after every use.

<p><b>Extreme Coating Hardness</b> <b>&gt;HV 2.500</b></p> <p>Offers impressive hardness on cutting edges as well as outstanding protection against wear and tear.</p>	<p><b>Minimal coating thickness</b> <b>µm 2-4</b></p> <p>This micron thin finish guarantees perfectly sharpened edges for high cutting quality.</p>	<p><b>Provides the lowest coefficient of friction</b> <b>0,1-0,2</b></p> <p>Very good running-in and low friction losses. Reduction of sticking. Ideal for high speeds in Nesting applications.</p>	<p><b>Optimal resistance to heat build up</b></p> <p>Reduced overheating. Cutting edges resist excessive wear up to 400°C.</p>
--	---	---	--

### BENEFITS



**3X**  
LONGER LIFE  
THAN UNCOATED

**DLCS CHROME COATING**  
provides 3 times longer life than uncoated tools!



Test performed in U.S. with 1/2" solid carbide compression spiral bit

- MACHINE:** FELDER® Profit H10 Nested Base/Overhead CNC Router
- WORKING PARAMETERS:** RPM = 18,000 - Feed = 20 mts/minute
- MATERIAL:** 19mm Melamine Chipboard
- APPLICATION:** Nesting Full Dimensioning
- PERFORMANCE:** DLCS coated bit cut 165 melamine panels  
Uncoated bit cut 56 melamine panels

FELDER® Profit H10



DLCS coated bit



Melamine Chipboard



Cut quality after 165 panels



# Solid Carbide Upcut & Downcut Spiral Bits



NEW  
NEW  
NEW

## 190.41 DLCS Chrome Coating Long Life



D mm	I mm	I <sub>1</sub> mm	L mm	S mm	Z	Box	ORDER NO. Right-hand rotation
8	32	7	80	8	2+2	10	190.080.41
9,52	28,6	7	76,2	9,52	2+2	10	190.504.41
10	32	7	80	10	2+2	10	190.100.41
10	42	7	90	10	2+2	10	190.101.41
12	42	7	90	12	2+2	10	190.120.41
12	52	7	100	12	2+2	10	190.121.41
12,7	25,4	12	76,2	12,7	2+2	10	190.505.41
12,7	28,6	12	76,2	12,7	2+2	10	190.506.41
12,7	34,9	12	88,9	12,7	2+2	10	190.507.41
12,7	41,3	12	101,6	12,7	2+2	10	190.508.41

### ...up & downcut mortising bits

9,52	22,2	4,8	76,2	9,52	2+2	10	190.513.41
9,52	25,4	5,2	76,2	9,52	3+3	10	190.813.41
12	25	5,2	83	12	3+3	10	190.320.41
12,7	22,2	5,2	76,2	12,7	2+2	10	190.515.41
12,7	34,9	5,2	88,9	12,7	2+2	10	190.517.41
12,7	28,5	6	76,2	12,7	3+3	10	190.815.41



## 190



D mm	I mm	I <sub>1</sub> mm	L mm	S mm	Z	Box	ORDER NO. Right-hand rotation
4	15	5	50	4	1+1	10	190.040.11
5	22	8	60	5	1+1	10	190.050.11
6	22	8	60	6	1+1	10	190.060.11
6,35	22,2	7	63,5	6,35	2+2	10	190.008.11
8	32	7	80	8	2+2	10	190.080.11
9,52	28,6	7	76,2	9,52	2+2	10	190.504.11
10	32	7	80	10	2+2	10	190.100.11
10	42	7	90	10	2+2	10	190.101.11
12	42	7	90	12	2+2	10	190.120.11
12	52	7	100	12	2+2	10	190.121.11
12,7	25,4	12	76,2	12,7	2+2	10	190.505.11
12,7	28,6	12	76,2	12,7	2+2	10	190.506.11
12,7	34,9	12	88,9	12,7	2+2	10	190.507.11
12,7	41,3	12	101,6	12,7	2+2	10	190.508.11
16	55	24	110	16	2+2	10	190.160.11
18	55	30	110	18	2+2	10	190.180.11

### ...up & downcut mortising bits

9,52	22,2	4,8	76,2	9,52	2+2	10	190.513.11
9,52	25,4	5,2	76,2	9,52	3+3	10	190.813.11
12	25	5,2	83	12	3+3	10	190.320.11
12,7	22,2	5,2	76,2	12,7	2+2	10	190.515.11
12,7	34,9	5,2	88,9	12,7	2+2	10	190.517.11
12,7	28,5	6	76,2	12,7	3+3	10	190.815.11

### TECHNICAL DETAILS:

- Premium quality HWM.
- 1+1 spiral cutting edges [Z1+1].
- 2+2 spiral cutting edges [Z2+2].
- 3+3 spiral cutting edges [Z3+3].
- Provide an excellent finish on both the upper and the lower side of the workpiece.

### APPLICATION:

used for efficient contour cutting, end-trimming and panel sizing on solid wood, wood composites, plastic materials and laminates at high feed speed. Ensure to properly clamp workpieces. Can be used on machining centres, point-to-point boring machines, CNC routers and hand-held routers equipped with chucks or adapters.



Results shown in this diagram are purely empirical, based merely on informative and hypothetical calculation. Each application may require different parameters in consideration of materials in use and machining conditions. CMT is not responsible for direct, indirect, incidental or consequential damages resulting from any defect, error or failure due to this diagram.

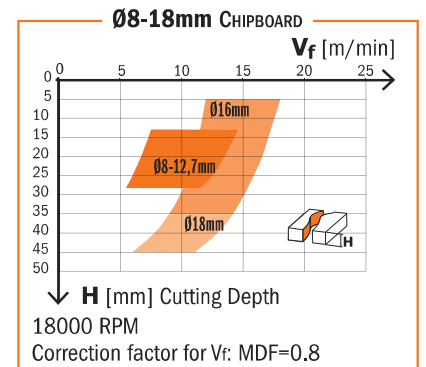
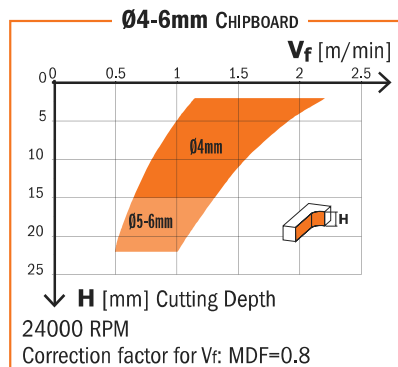



## 198 Upcut Spiral



D mm	I mm	L mm	S mm		ORDER NO. Right-hand rotation
3	12	50	3	10	198.030.11
3,18	12,7	50,8	6,35	10	198.001.11
4	15	50	4	10	198.040.11
4,76	15,87	50,8	6,35	10	198.005.11
5	17	50	5	10	198.050.11
6	22	60	6	10	198.060.11
6,35	19,05	50,8	6,35	10	198.007.11
6,35	25,4	63,5	6,35	10	198.008.11
8	22	70	8	10	198.080.11
8	32	80	8	10	198.081.11
9,52	28,57	76,2	9,52	10	198.504.11
10	32	70	10	10	198.100.11
10	42	80	10	10	198.101.11
10	52	90	10	10	198.102.11
12	32	83	12	10	198.120.11

### TECHNICAL DETAILS:

- Premium quality HWM.
- 1 spiral cutting edge [Z1].
- Provide an excellent finish on the lower side of the workpiece.
- **Upward chip ejection.**

### APPLICATION:

used for efficient contour cutting, end-trimming and panel sizing on solid wood, wood composites, plastic materials and laminates at high feed speed. Ensure to properly clamp workpieces.  
Can be used on machining centres, point-to-point boring machines, CNC routers and hand-held routers equipped with chucks or adapters.



## 198 Downcut Spiral



D mm	I mm	L mm	S mm		ORDER NO. Right-hand rotation
6	27	60	6	10	198.660.11

### TECHNICAL DETAILS:

- Premium quality HWM.
- 1 spiral cutting edge [Z1].
- Provide an excellent finish on the top side of the workpiece.
- **Upward chip ejection.**

### APPLICATION:

used for efficient contour cutting, end-trimming and panel sizing on solid wood, wood composites, plastic materials and laminates at high feed speed. Ensure to properly clamp workpieces.  
Can be used on machining centres, point-to-point boring machines, CNC routers and hand-held routers equipped with chucks or adapters.

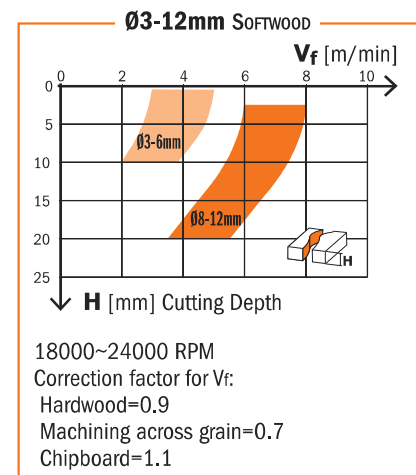
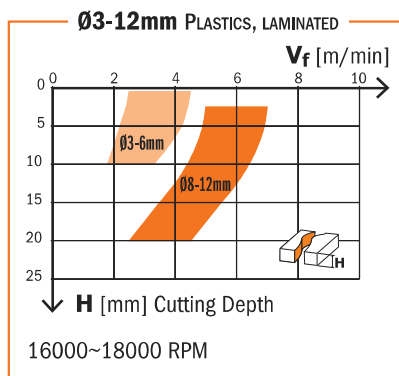

Results shown in this diagram are purely empirical, based merely on informative and hypothetical calculation. Each application may require different parameters in consideration of materials in use and machining conditions. CMT is not responsible for direct, indirect, incidental or consequential damages resulting from any defect, error or failure due to this diagram.



## 191



D mm	I mm	L mm	S mm		ORDER NO. Right-hand rotation
3	12	50	3	10	191.030.11
3	12	60	6	10	191.630.11
3	12	60	8	10	191.830.11
3,18	12,7	50,8	6,35	10	191.001.11
3,5	12	60	6	10	191.635.11
3,97	12,7	50,8	6,35	10	191.003.11
4	15	50	4	10	191.040.11
4	15	60	6	10	191.640.11
4	15	60	8	10	191.840.11
4,76	19,05	50,8	6,35	10	191.005.11
5	17	50	5	10	191.050.11
5	17	60	6	10	191.650.11
5	17	60	8	10	191.850.11
6	27	70	6	10	191.060.11
6	27	70	8	10	191.860.11
6,35	19,05	50,8	6,35	10	191.007.11
6,35	25,4	63,5	6,35	10	191.008.11
7	32	80	8	10	191.870.11
7,94	25,4	76,2	12,7	10	191.501.11
8	22	70	8	10	191.080.11
8	32	80	8	10	191.081.11
8	42	90	8	10	191.082.11
9	32	83	12	10	191.890.11
9,52	31,75	82,5	12,7	10	191.503.11
10	32	80	8	10	191.800.11
10	32	80	10	10	191.100.11
10	32	83	12	10	191.900.11
10	42	90	10	10	191.101.11
10	42	90	12	10	191.901.11
12	35	83	8	10	191.820.11
12	35	83	12	10	191.120.11
12	42	90	12	10	191.121.11
12	52	100	12	10	191.122.11
12,7	31,75	76,2	12,7	10	191.505.11
12,7	38,1	88,9	12,7	10	191.506.11
12,7	50,8	101,6	12,7	10	191.507.11
14	50	110	14	1	191.140.11
16	55	110	16	1	191.160.11
16	35	90	16	1	191.161.11
16	72	120	16	1	191.165.11
20	72	120	20	1	191.200.11

### Ø12-14mm PLASTICS, LAMINATED

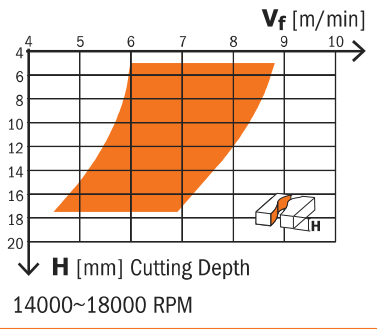

### Ø12-20mm SOFTWOOD

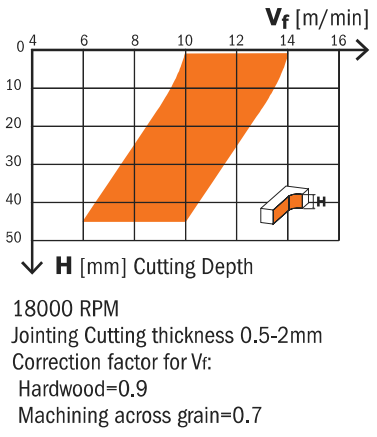

#### TECHNICAL DETAILS:

- Premium quality HWM.
- 2 spiral cutting edges [Z2].
- Provide an excellent finish on the lower side of the workpiece.
- **Upward chip ejection.**

#### APPLICATION:

used for efficient contour cutting, end-trimming and panel sizing on solid wood, wood composites, plastic materials and laminates at high feed speed. Ensure to properly clamp workpieces.

Can be used on machining centres, point-to-point boring machines, CNC routers and hand-held routers equipped with chucks or adapters.



Results shown in this diagram are purely empirical, based merely on informative and hypothetical calculation. Each application may require different parameters in consideration of materials in use and machining conditions. CMT is not responsible for direct, indirect, incidental or consequential damages resulting from any defect, error or failure due to this diagram.



# Solid Carbide Downcut Spiral Bits

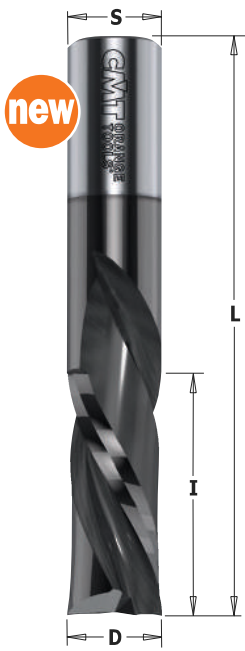

new



## 192.41 DLCS Chrome Coating Long Life



D mm	I mm	L mm	S mm		ORDER NO. Right-hand rotation
6,35	19,05	50,8	6,35	10	192.007.41
6,35	25,4	63,5	6,35	10	192.008.41
9,52	31,75	82,5	12,7	10	192.503.41
12,7	31,75	76,2	12,7	10	192.505.41
12,7	38,1	88,9	12,7	10	192.506.41
12,7	50,8	101,6	12,7	10	192.507.41

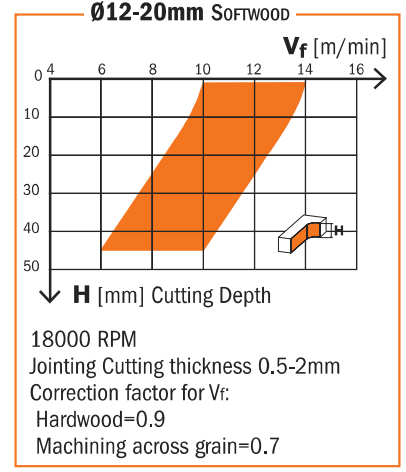
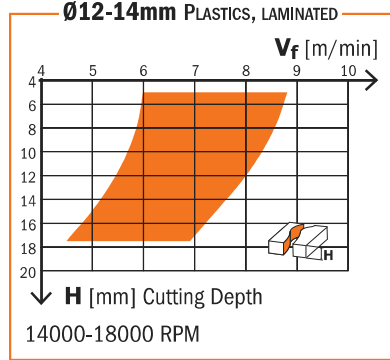

Results shown in this diagram are purely empirical, based merely on informative and hypothetical calculation. Each application may require different parameters in consideration of materials in use and machining conditions. CMT is not responsible for direct, indirect, incidental or consequential damages resulting from any defect, error or failure due to this diagram.



## 192



D mm	I mm	L mm	S mm		ORDER NO. Right-hand rotation
3	12	50	3	10	192.030.11
3	12	60	6	10	192.630.11
3	12	60	8	10	192.830.11
3,18	12,7	50,8	6,35	10	192.001.11
3,97	12,7	50,8	6,35	10	192.003.11
4	15	50	4	10	192.040.11
4	15	60	6	10	192.640.11
4	15	60	8	10	192.840.11
4,76	19,05	50,8	6,35	10	192.005.11
5	17	50	5	10	192.050.11
5	17	60	6	10	192.650.11
5	17	60	8	10	192.850.11
6	27	70	6	10	192.060.11
6	27	70	8	10	192.860.11
6,35	19,05	50,8	6,35	10	192.007.11
6,35	25,4	63,5	6,35	10	192.008.11
7,94	25,4	76,2	12,7	10	192.501.11
8	22	70	8	10	192.080.11
8	32	80	8	10	192.081.11
8	42	90	8	10	192.082.11
9,52	31,75	82,5	12,7	10	192.503.11
10	32	80	8	10	192.800.11
10	32	80	10	10	192.100.11
10	42	90	10	10	192.101.11
10	32	83	12	10	192.900.11
12	35	83	8	10	192.820.11
12	35	83	12	10	192.120.11
12,7	31,75	76,2	12,7	10	192.505.11
12,7	38,1	88,9	12,7	10	192.506.11
12,7	50,8	101,6	12,7	10	192.507.11
14	52	110	14	1	192.140.11
16	55	110	16	1	192.160.11

### TECHNICAL DETAILS:

- Premium quality HWM.
- 2 spiral edges [Z2].
- Provide an excellent finish on the upper side of the workpiece.
- **Downward chip ejection.**

### APPLICATION:

used for efficient contour cutting, end-trimming and panel sizing on solid wood, wood composites, plastic materials and laminates at high feed speed. Ensure to properly clamp workpieces. Can be used on machining centres, point-to-point boring machines, CNC routers and hand-held routers equipped with chucks or adapters.

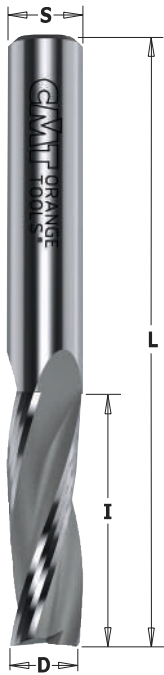

## 193



D mm	I mm	L mm	S mm		ORDER NO. Right-hand rotation	ORDER NO. Left-hand rotation
8	32	80	8	10	193.081.11	193.081.12
10	32	80	10	10	193.100.11	193.100.12
10	42	90	10	10	193.101.11	
12	35	83	12	10	193.120.11	193.120.12
12	42	90	12	10	193.121.11	
12	52	100	12	10	193.122.11	
14	58	110	14	1	193.140.11	
16	55	110	16	1	193.160.11	193.160.12
16	35	90	16	1	193.161.11	
16	72	120	16	1	193.165.11	
18	55	110	18	1	193.180.11	
20	60	120	20	1	193.200.11	193.200.12
20	70	120	20	1	193.201.11	
20	102	165	20	1	193.202.11	

**NEW**

### TECHNICAL DETAILS:

- Premium quality HWM.
- 3 spiral cutting edges [Z3].
- Provide an excellent finish on the lower side of the workpiece.
- **Upward chip ejection.**

### APPLICATION:

used for efficient contour cutting, end-trimming and panel sizing on solid wood, wood composites, plastic materials and laminates at high feed speed. Ensure to properly clamp workpieces. Can be used on machining centres, point-to-point boring machines, CNC routers and hand-held routers equipped with chucks or adapters.

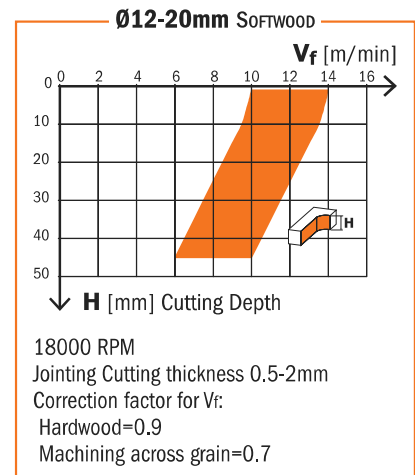
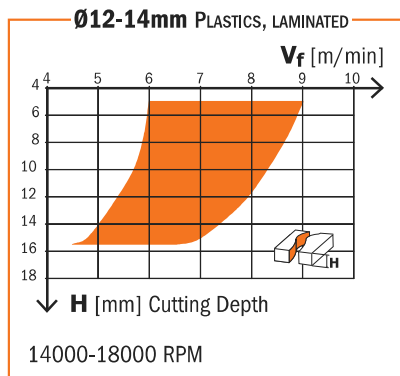

Results shown in this diagram are purely empirical, based merely on informative and hypothetical calculation. Each application may require different parameters in consideration of materials in use and machining conditions. CMT is not responsible for direct, indirect, incidental or consequential damages resulting from any defect, error or failure due to this diagram.

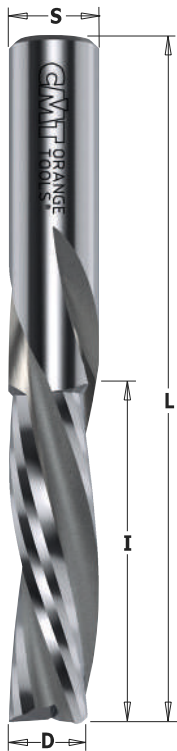

## 194



D mm	I mm	L mm	S mm		ORDER NO. Right-hand rotation	ORDER NO. Left-hand rotation
10	32	80	10	10	194.100.11	
10	42	90	10	10	194.101.11	
12	35	83	12	10	194.120.11	194.120.12
12	42	90	12	10	194.121.11	
14	50	110	14	1	194.140.11	
16	55	110	16	1	194.160.11	194.160.12
16	35	90	16	1	194.161.11	
18	55	110	18	1	194.180.11	
20	60	120	20	1	194.200.11	194.200.12
20	72	120	20	1	194.201.11	
20	102	165	20	1	194.202.11	

### TECHNICAL DETAILS:

- Premium quality HWM.
- 3 spiral cutting edges [Z3].
- Provide an excellent finish on the upper side of the workpiece.
- **Downward chip ejection.**

### APPLICATION:

used for efficient contour cutting, end-trimming and panel sizing on solid wood, wood composites, plastic materials and laminates at high feed speed. Ensure to properly clamp workpieces. Can be used on machining centres, point-to-point boring machines, CNC routers and hand-held routers equipped with chucks or adapters.

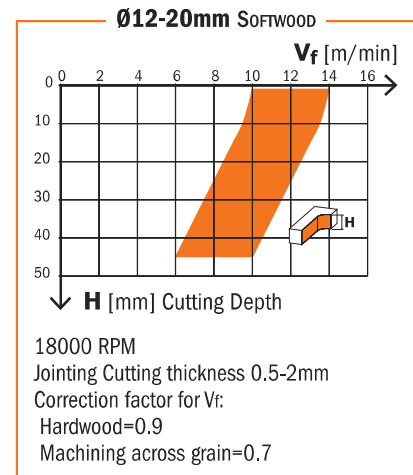
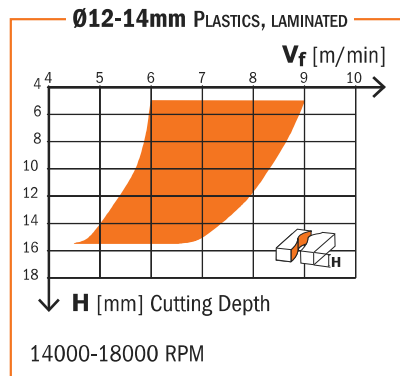

Results shown in this diagram are purely empirical, based merely on informative and hypothetical calculation. Each application may require different parameters in consideration of materials in use and machining conditions. CMT is not responsible for direct, indirect, incidental or consequential damages resulting from any defect, error or failure due to this diagram.

# Solid Carbide Upcut Spiral Bits with Chip-Breaker



## 195



D mm	I mm	L mm	S mm		ORDER NO. Right-hand rotation	ORDER NO. Left-hand rotation
8	32	80	8	10	195.081.11	195.081.12
8	42	90	8	10	195.082.11	
10	32	80	10	10	195.100.11	195.100.12
10	42	90	10	10	195.101.11	
12	35	83	12	10	195.120.11	195.120.12
12	42	90	12	10	195.121.11	
12	52	100	12	10	195.122.11	
12,7	38,1	88,9	12,7	10	195.506.11	
14	58	110	14	1	195.140.11	
16	55	110	16	1	195.160.11	195.160.12
16	35	90	16	1	195.161.11	
16	72	120	16	1	195.165.11	
18	55	110	18	1	195.180.11	
20	60	120	20	1	195.200.11	195.200.12
20	72	120	20	1	195.201.11	
20	102	165	20	1	195.202.11	

**TECHNICAL DETAILS:**

- Premium quality HWM.
- 3 spiral cutting edges [Z3R].
- Chip breaker teeth.
- Max 0.3mm tooth depth.
- Provide an excellent finish on the lower side of the workpiece.
- **Upward chip ejection.**

**APPLICATION:**

used for efficient contour cutting, end-trimming and panel sizing on solid wood, wood composites, plastic materials and laminates at high feed speed. Ensure to properly clamp workpieces. Can be used on machining centres, point-to-point boring machines, CNC routers and hand-held routers equipped with chucks or adapters.

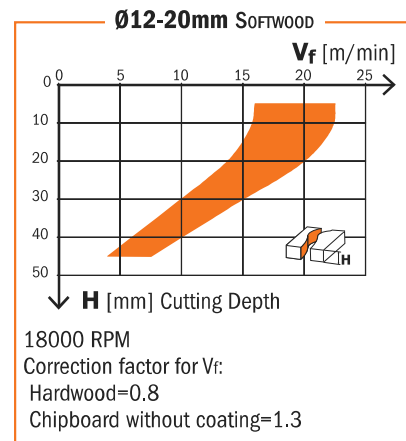
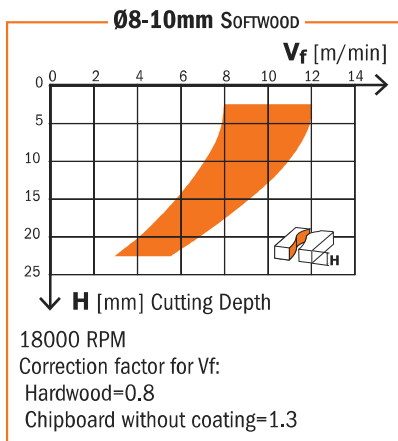

Results shown in this diagram are purely empirical, based merely on informative and hypothetical calculation. Each application may require different parameters in consideration of materials in use and machining conditions. CMT is not responsible for direct, indirect, incidental or consequential damages resulting from any defect, error or failure due to this diagram.

# Solid Carbide Upcut Spiral Bits

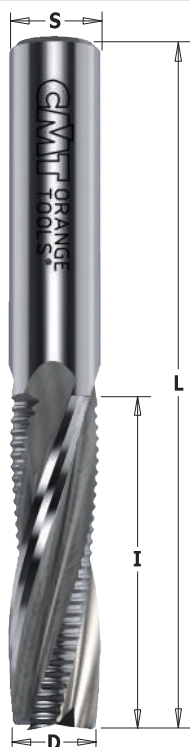

## 197



D mm	I mm	L mm	S mm		ORDER NO. Right-hand rotation	
12	42	90	12	10	197.121.11	
14	50	110	14	1	197.140.11	
16	55	110	16	1	197.160.11	
16	35	90	16	1	197.161.11	
18	55	110	18	1	197.180.11	
20	60	120	20	1	197.200.11	
20	72	120	20	1	197.201.11	

**TECHNICAL DETAILS:**

- Premium quality HWM.
- 4 spiral cutting edges (2 with chip-breaker) [Z2+2R].
- Max 0.1mm tooth depth.
- Provide excellent finish on the lower side of the workpiece.
- **Upward chip ejection.**

**APPLICATION:**

used for efficient contour cutting, end-trimming and panel sizing on solid wood and wood composites. Can be used on machining centres, point-to-point boring machines, CNC routers and hand-held routers equipped with chucks or adapters.



**The special 4 flute design (Z2 finishing + Z2R with chipbreaker) allows high speed with excellent finish on the workpiece.**



# Solid Carbide Downcut Spiral Bits with Chip-Breaker

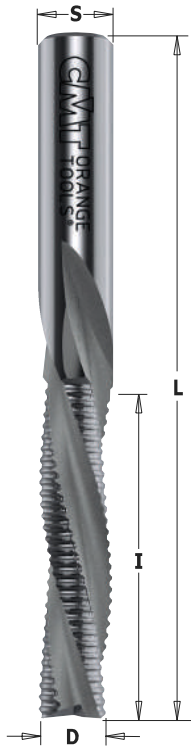

**196**



D mm	I mm	L mm	S mm		ORDER NO. Right-hand rotation	ORDER NO. Left-hand rotation
8	32	80	8	10	196.081.11	
10	42	90	10	10	196.101.11	
12	35	83	12	10	196.120.11	196.120.12
12	42	90	12	10	196.121.11	
12	52	100	12	10	196.122.11	
12,7	38,1	88,9	12,7	10	196.506.11	
14	50	110	14	1	196.140.11	
16	55	110	16	1	196.160.11	196.160.12
18	55	110	18	1	196.180.11	
20	60	120	20	1	196.200.11	
20	72	120	20	1	196.201.11	

**TECHNICAL DETAILS:**

- Premium quality HWM.
- 3 spiral cutting edges [Z3R].
- Chip breaker teeth.
- Max 0.3mm tooth depth.
- Provide excellent finish on the upper side of the workpiece.
- **Downward chip ejection.**

**APPLICATION:**

used for efficient contour cutting, end-trimming and panel sizing on solid wood, wood composites, plastic materials and laminates at high feed speed. Ensure to properly clamp workpieces. Can be used on machining centres, point-to-point boring machines, CNC routers and hand-held routers equipped with chucks or adapters.

**Ø8-10mm SOFTWOOD**

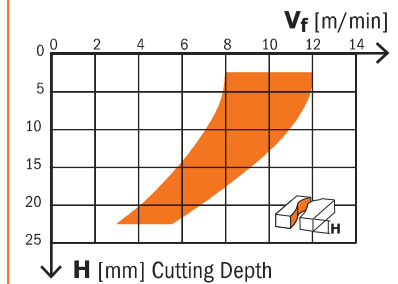

18000 RPM  
Correction factor for Vr:  
Hardwood=0.8  
Chipboard without coating=1.3

**Ø12-20mm SOFTWOOD**

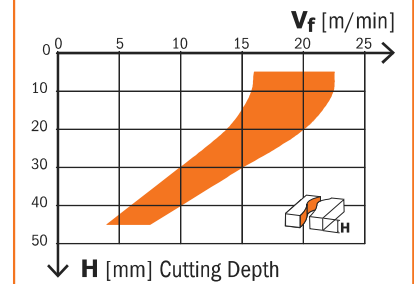

18000 RPM  
Correction factor for Vr:  
Hardwood=0.8  
Chipboard without coating=1.3

Results shown in this diagram are purely empirical, based merely on informative and hypothetical calculation. Each application may require different parameters in consideration of materials in use and machining conditions. CMT is not responsible for direct, indirect, incidental or consequential damages resulting from any defect, error or failure due to this diagram.

# Solid Carbide Upcut & Downcut Spiral Bit with DLCS Chrome Coating



**new**



**190.04**

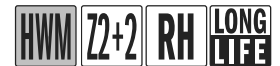

D mm	d mm	I mm	L mm	S mm	Z		ORDER NO. Right-hand rotation
9,8	7	25	83	12	2+2	10	190.001.04

LAMELLO® P-SYSTEM® components can be crafted on a CNC machining center. Groovework is carried out along the edge workpiece with a spiral cutter coated with DLCS for long life.



For use only on 5 axis CNC machines.



1



2



3



4





## 195



D mm	I mm	I <sub>1</sub> mm	L mm	S mm		ORDER NO. Right-hand rotation
<b>With Chip-Breaker</b>						
14	95*	45	150	14	1	195.142.11
14	125*	45	170	14	1	195.144.11
16	95*	45	150	16	1	195.162.11
16	120*	50	170	16	1	195.164.11
18	95*	45	150	18	1	195.182.11
<b>Without Chip-Breaker</b>						
16	95*	45	150	16	1	193.162.11

\* The maximum cutting length is achieved in 2-3 passes.

### TECHNICAL DETAILS:

- Premium quality HWM.
- 3 spiral cutting edges [Z3] and [Z3R].
- Max 0.3mm tooth depth.
- Provide an excellent finish on the lower side of the workpiece.
- Seat for seeger ring (*not included*).
- **Upward chip ejection.**

### APPLICATION:

used for efficient contour cutting, end-trimming and panel sizing on solid wood, wood composites, plastic materials and laminates at high feed speed. Ensure to properly clamp workpieces. Can be used on machining centres, point-to-point boring machines, CNC routers and hand-held routers equipped with chucks or adapters.

### GUIDE FOR MACHINING DEEP SLOTS

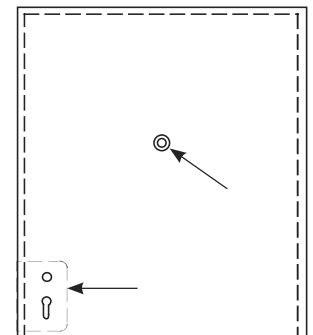
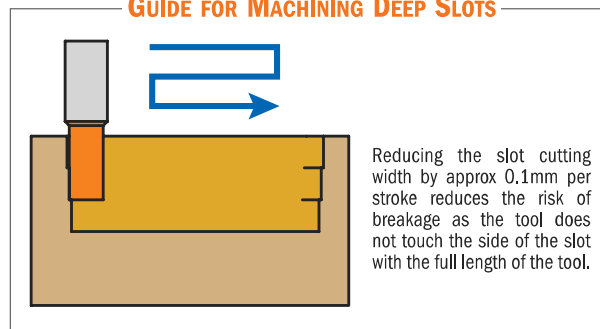

# Solid Carbide Upcut Spiral Bits with Chip-Breaker for 60° V-Point Locksets



## 195.143/163

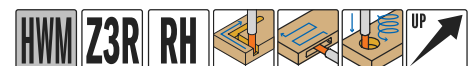

D mm	I mm	L mm	S mm		ORDER NO. Right-hand rotation
14	58	110	14	1	195.143.11
16	55	110	16	1	195.163.11

# Solid Carbide Upcut Spiral Bits without Chip-Breaker for 60° V-Point Locksets

## 191.143/163

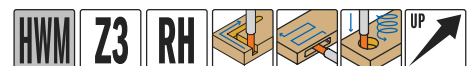

D mm	I mm	L mm	S mm		ORDER NO. Right-hand rotation
14	50	110	14	1	191.143.11
16	55	110	16	1	191.163.11

### TECHNICAL DETAILS:

- Premium quality HWM.
- 3 spiral cutting edges [Z3].
- Provide an excellent finish on the lower side of the workpiece.
- **Upward chip ejection.**

### APPLICATION:

used for efficient contour cutting, end-trimming and panel sizing on solid wood, wood composites, plastic materials and laminates at high feed speed. Ensure to properly clamp workpieces. Can be used on machining centres, point-to-point boring machines, CNC routers and hand-held routers equipped with chucks or adapters.

# Spiral Bits with Insert Knives & Chip-Breaker for Locksets



## 662

D mm	I mm	L mm	S mm		ORDER NO. Right-hand rotation
16	23/95*	150	16	1	662.160.11

INSERT CARBIDE Z2R RH 2X CUTTING

Spare parts

790.230.2R - 790.230.3R	990.082.00	991.063.00

Spare parts: **790.230.2R** 23x7x1.5mm 2-RT HWM K2020 knives (Minimum 10 pieces or multiple)  
**790.230.3R** 23x7x1.5mm 3-RT HWM K2020 knives (Minimum 10 pieces or multiple)

\* The 95mm length is achieved in 4-5 passes.

### TECHNICAL DETAILS:

- DENSIMET® high density tungsten alloy for low-vibration.
- 2 cutting edges [Z2R] with chip-breakers

### APPLICATION:

used for efficient contour cutting, end-trimming and panel sizing on solid wood, wood composites, plastic materials and laminates at high feed speed. Ensure to properly clamp workpieces. Can be used on machining centres, point-to-point boring machines, CNC routers and hand-held routers equipped with chucks or adapters. Cost-effective solution with respect to brazed and spiral in tungsten carbide.

### SAFETY TIPS:

The **TW-006** Torque Screwdriver is recommended for the proper fastening of screws (see page 406).

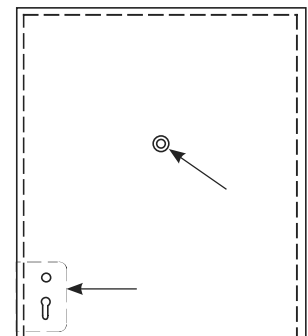
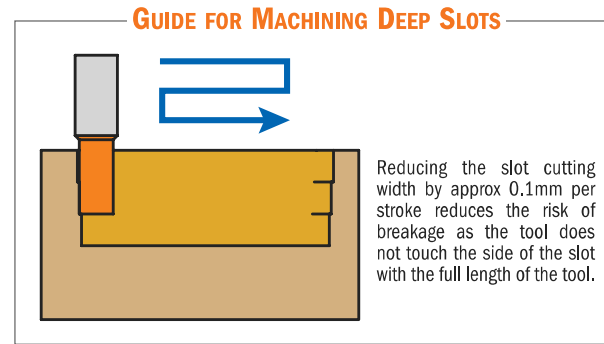

# Upcut Spiral Bits with Chipbreaker for Glue-Laminated Wooden Beams



## 195

D mm	I mm	L mm	S mm		ORDER NO. Right-hand rotation
□ 30	170	235	30	1	Y195.300.51
40	165	235	30	1	195.400.51
50	215	295	30	1	195.500.51

HSS Z3R RH UP

### □ On request

Available by special request bits without chip breaker, with left-hand rotation and/or custom dimensions.

### TECHNICAL DETAILS:

- High speed cobalt steel.
- 3 upcut spiral cutting edges with chipbreaker [Z3R].
- Resharpenable cutters.
- Max 6000~10000 RPM.
- Maximum feed speed 2m/minute.
- **Upward chip ejection.**

### APPLICATION:

used for cutting, copying, and routing on glue-laminated wooden beams. For use on HUNDEGGER® machines.

# Solid Carbide Upcut 2D/3D Carving Tapered Ball Nose Spiral Bits



## 152



D mm	R mm	A	I mm	L mm	S mm	Z		ORDER NO. Right-hand rotation
0,8	0,4	5,5°	25	70	6	3	10	152.060.082
0,8	0,4	6,2°	25,4	76,2	6,35	3	10	152.064.082
1,6	0,8	4,5°	25	70	6	3	10	152.060.162
1,6	0,8	5,4°	25,4	76,2	6,35	3	10	152.064.162
1,6	0,8	5,5°	30	80	8	3	10	152.080.163
2	1	3°	80	120	12	2	10	152.120.208
3,2	1,6	2,5°	30	70	6	3	10	152.060.323
3,2	1,6	3,6°	25,4	76,2	6,35	3	10	152.064.322
3,2	1,6	2,5°	50	90	8	3	10	152.080.325
6	3	3°	50	100	12	2	10	152.120.605
6,4	3,2	3°	50,8	101,6	12,7	2	10	152.127.635

### TECHNICAL DETAILS:

- Premium quality HWM.
- Upcut spiral cutting edges [Z2/Z3].
- **Excellent finish on the lower side of the work piece.**
- Upward chip ejection.

### APPLICATION:

- specially designed for 2D and 3D CNC profiling and carving in plastic, aluminum & wood for several uses like:
- A perfect bit for 3D carving
  - Precision 2D and 3D large scale carving
  - Great for deep profiling
  - Dimensional signage
  - 3D millwork
  - 2D and 3D contouring, profiling, modeling and pattern making for cabinetry, sign making, furniture making and jewelry mold making
  - Perfect for model-makers on large 3D milling profiles in abrasive EPS foam and other materials.
  - **Ideal on aluminum, plastic and wood-based materials.**

### EXCELLENCE FOR CUTTING

- Acrylonitrile-Butadiene-Styrene (ABS)
- Acrylic
- Acrylic Stone
- Aluminum
- Brass
- Bronze
- Composite
- Copper
- Ethylene-vinyl Acetate Foam (EVA)
- Expanded Polypropylene (EPP)
- Expanded Polystyrene Foam (EPS)
- Extruded Polystyrene Foam (XPS)
- Fiberglass
- Fiberglass PCB Board
- Foam Board
- Graphite
- HDPE
- HDU
- 20lbs High Density Urethane
- MDF/HDF
- Phenolics
- Phenolic Composites
- Plastics
- Poly (methyl methacrylate) (PMMA)
- Polyethylene Foam
- Polyurethane Foam
- PVC
- PVC Foam Board
- Sign Board
- Sign Foam

- Titanium
- Tooling Board
- Wood
- XPE (Cross Linked Polyethylene) Foam

### TIPS FOR MILLING PLASTICS

- pay attention to heat input
- pay attention to chip-loads when using small diameters
- use air-blast to keep chip away and cooling the tool

### ALSO EXCELLENCE FOR

- CORIAN®
- COROPLAST®
- DIBOND®
- ETHAFOAM®
- LEXAN®
- PALFOAM®
- POLYLAM®

# Round Nose Solid Carbide Upcut Spiral Bits



## 199



D mm	R mm	I mm	L mm	S mm		ORDER NO. Right-hand rotation
3,18	1,6	12,7	50,8	6,35	10	199.001.11
6	3	27	70	6	10	199.060.11
6,35	3,18	25,4	63,5	6,35	10	199.008.11
8	4	32	80	8	10	199.081.11
9,52	4,76	28,57	76,2	9,52	10	199.504.11
10	5	32	80	10	10	199.100.11
12	6	35	80	12	10	199.120.11
12,7	6,35	31,75	76,2	12,7	10	199.505.11
15,88	7,94	57,15	109,5	15,88	1	199.509.11
16	8	55	110	16	1	199.160.11
19,05	9,52	57,15	109,5	19,05	1	199.511.11

### TECHNICAL DETAILS:

- Premium quality HWM.
- 2 upcut spiral cutting edges [Z2].
- Excellent finish on the lower side of the work piece.
- **Upward chip ejection.**

### APPLICATION:

used for efficient contour cutting, end-trimming and panel sizing on solid wood, wood composites, plastic materials and laminates at high feed speed. Ensure to properly clamp workpieces. Can be used on machining centres, point-to-point boring machines, CNC routers and hand-held routers equipped with chucks or adapters. Cost-effective solution with respect to brazed and spiral in tungsten carbide.



# Solid Surface and Fiberglass Bit with DLCS Chrome Coating



**151 XTREME PERFORMANCE**



D mm	I mm	L mm	S mm		ORDER NO. Right-hand rotation
6	19	60	6	10	<b>151.060.19E</b>
6,35	25,4	63,5	6,35	10	<b>151.064.25E</b>
8	25	60	8	10	<b>151.080.25E</b>
12	25	75	12	10	<b>151.120.25E</b>
12,7	38	89	12,7	10	<b>151.127.38E</b>

**TECHNICAL DETAILS:**

- Premium quality HWM
- Special positively ground cutting edge sharpening for excellent finish

**APPLICATION:**

used for efficient contour cutting, end-trimming and panel sizing on glass fiber and fiberglass, phenolic and composite material.  
For use on machining centres, point-to-point boring machines, CNC routers and hand-held routers equipped with chucks or adapters.



- DLCS CHROME COATING:**
- Superb wear resistance
  - Better chip clearance
  - Superior cutting quality
  - Less overheating
  - More productivity



**DLCS CHROME COATING** provides 3 times longer life than uncoated tools!

# Solid Surface and Fiberglass Bit with DLCS Chrome Coating



**151 XTREME PERFORMANCE**



D mm	I mm	L mm	S mm		ORDER NO. Right-hand rotation
6	19	60	6	10	<b>151.060.19D</b>
6,35	25,4	63,5	6,35	10	<b>151.064.25D</b>
8	25	60	8	10	<b>151.080.25D</b>
12	25	75	12	10	<b>151.120.25D</b>
12,7	38	89	12,7	10	<b>151.127.38D</b>

**TECHNICAL DETAILS:**

- Premium quality HWM
- Special positively ground cutting edge sharpening for excellent finish

**APPLICATION:**

used for efficient contour cutting, end-trimming and panel sizing on fiberglass, glass fiber phenolic and composite material. The 135° tooth geometry allows vertical feeding minimizing the bending of the workpiece. To be used on machining centres, point-to-point boring machines, CNC routers and hand-held routers equipped with chucks or adapters.



- DLCS CHROME COATING:**
- Superb wear resistance
  - Better chip clearance
  - Superior cutting quality
  - Less overheating
  - More productivity

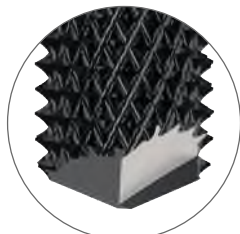

Sharpening 135°



**DLCS CHROME COATING** provides 3 times longer life than uncoated tools!