











-  Profiled standard blanks
-  Profilierte Standardblanketts
-  Plaquettes standard profilées
-  Placchette profilate standard
-  Cuchillas perfiladas standard

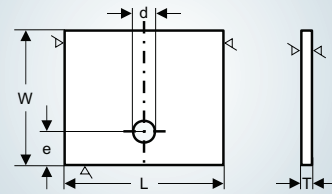
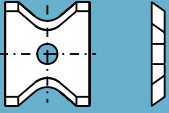
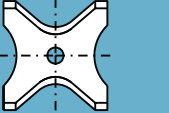
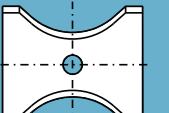
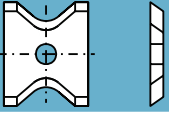
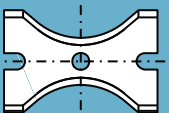







For Leuco system and
Howema system*

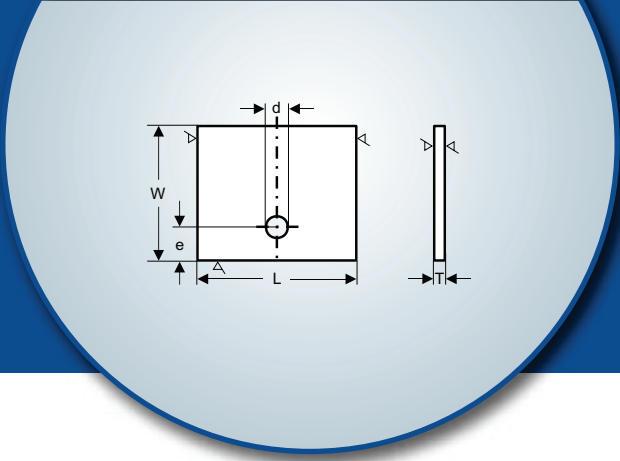



For Leuco system*	L mm	W mm	T mm	d mm	R mm	T04F	T03SMG	T10MG
	13.0	16.0	2.0	4.0	2.0	032836	032876	032904
	13.0	16.0	2.0	4.0	3.0	032837	032877	032909
	13.0	16.0	2.0	4.0	4.0	032838	032878	032908
	20.0	21.0	2.0	4.0	5.0	032839	113392	113397
	20.0	21.0	2.0	4.0	6.0	032840	113393	113398
	20.0	21.0	2.0	4.0	7.0	032841	113394	113399
	20.0	21.0	2.0	4.0	8.0	032842	113395	032915
	26.0	24.0	2.0	4.0	9.0	032843	032882	032919
	26.0	24.0	2.0	4.0	10.0	032844	032883	032920
	26.0	24.0	2.0	4.0	11.0	032845	052559	032921
	26.0	24.0	2.0	4.0	12.0	032846	032885	032922
	26.0	24.0	2.0	4.0	13.0	032847	032886	110692
		30.0	25.0	2.0	4.0	14.0	032848	033782
30.0		25.0	2.0	4.0	15.0	032849	033785	033786
30.0		25.0	2.0	4.0	16.0	032850	033788	033789
For Howema system*	L mm	W mm	T mm	d mm	R mm	T04F	T03SMG	T10MG
	13.0	14.0	1.5	3.2	2.0	016376	033809	033810
	13.0	14.0	1.5	3.2	3.0	016377	033812	033813
	13.0	14.0	1.5	3.2	4.0	016378	033815	033816
	20.0	16.0	2.0	3.2	5.0	016379	033818	033819
	20.0	16.0	2.0	3.2	6.0	016380	033821	033822
	20.0	16.0	2.0	3.2	7.0	016381	033824	033825
	20.0	16.0	2.0	3.2	8.0	016382	033827	033828
	26.0	18.0	2.0	3.2	9.0	016383	033830	033831
	26.0	18.0	2.0	3.2	10.0	016384	033833	033834
	26.0	18.0	2.0	3.2	11.0	016385	033836	033837
	26.0	18.0	2.0	3.2	12.0	016386	033839	033840
	26.0	18.0	2.0	3.2	12.5	016391	033867	033868
	30.0	20.0	2.0	3.2	13.0	016387	033842	033843
	30.0	20.0	2.0	3.2	14.0	016388	033845	033846
	30.0	20.0	2.0	3.2	15.0	016389	033848	033849
	30.0	20.0	2.0	3.2	16.0	016390	033851	033852
		40.0	28.0	2.0	3.2	17.0	016371	033854
40.0		28.0	2.0	3.2	18.0	016372	033857	033858
40.0		28.0	2.0	3.2	19.0	016373	033860	033861
40.0		28.0	2.0	3.2	20.0	016374	033863	033864

* For use in Leuco/Howema-cutterheads only
 * Nur zur Verwendung in Messerköpfen der Firma Leuco bzw. Howema
 * Utilisation limitée aux porte outils de l'entreprises Leuco et Howema
 * Da usare solo su teste portacoltelli della Leuco - Howema
 * Sólo para empleo con portacuchillas de la firma Leuco/Howema







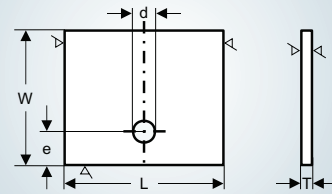

-  Profiled standard blanks
-  Profilierte Standardblanketts
-  Plaquettes standard profilées
-  Placchette profilate standard
-  Cuchillas perfiladas standard







	L mm	W mm	T mm	d mm	R mm	T04F	T03SMG	T10MG
	12.0	12.0	1.5	4.0	2.0	016426	033022	033024
	12.0	12.0	1.5	4.0	3.0	016427	033021	033025
	12.0	12.0	1.5	4.0	4.0	016428	033023	033026
	12.0	13.0	2.0	4.0	2.0	020990	033877	033878
	12.0	13.0	2.0	4.0	2.5	022185	033874	033875
	12.0	13.0	2.0	4.0	3.0	020853	033871	033872
	16.0	14.0	2.0	4.0	3.0	039045		
	16.0	17.5	2.0	3.0	2.0	016515	033880	033881
	16.0	17.5	2.0	3.0	3.0	016516	033883	033884
	16.0	17.5	2.0	3.0	4.0	016518	033886	033887
	16.0	17.5	2.0	3.0	5.0	016519	033889	033890
	16.0	17.5	2.0	3.5	2.0	016469	033892	033893
	16.0	17.5	2.0	3.5	3.0	016470	033895	033896
	16.0	17.5	2.0	3.5	4.0	016472	033898	033899
	16.0	17.5	2.0	3.5	5.0	016473	033901	033902
	16.0	17.5	2.0	3.5	6.0	016474	033904	033905
	16.0	17.5	2.0	4.0	2.0	016477	032968	032973
	16.0	17.5	2.0	4.0	3.0	016478	032969	032974
	16.0	17.5	2.0	4.0	4.0	016479	032970	032975
	16.0	17.5	2.0	4.0	5.0	016480	032971	032976
	16.0	17.5	2.0	4.4	2.0	016510	033907	033908
	16.0	17.5	2.0	4.4	3.0	016511	033910	033911
16.0	17.5	2.0	4.4	4.0	016512	033913	033914	
16.0	17.5	2.0	4.4	5.0	016513	033916	033917	
	24.0	20.0	2.0	4.4	6.0	033919	033924	033925
	24.0	20.0	2.0	4.4	7.0	033920	033927	033928
	24.0	20.0	2.0	4.4	8.0	033921	033930	033931
	24.0	20.0	2.0	4.4	9.0	033922	033933	033934
	24.0	20.0	2.0	4.4	10.0	033923	033936	033937
	20.0	20.5	2.0	4.0	2.0	016495	032991	032996
	20.0	20.5	2.0	4.0	3.0	016496	032992	032997
	20.0	20.5	2.0	4.0	4.0	016497	032993	032998
	20.0	20.5	2.0	4.0	5.0	016498	032994	032999
	20.0	20.5	2.0	4.0	6.0	016499	032995	033000
	20.0	20.5	2.0	4.0	2.0	016500	033007	033011
	20.0	20.5	2.0	4.0	3.0	016501	033006	033012
	20.0	20.5	2.0	4.0	4.0	016502	033008	033013
	20.0	20.5	2.0	4.0	5.0	016503	033009	033014
	20.0	20.5	2.0	4.0	6.0	016504	033010	033015







-  Profiled standard blanks
-  Profilierte Standardblanketts
-  Plaquettes standard profilées
-  Placchette profilate standard
-  Cuchillas perfiladas standard

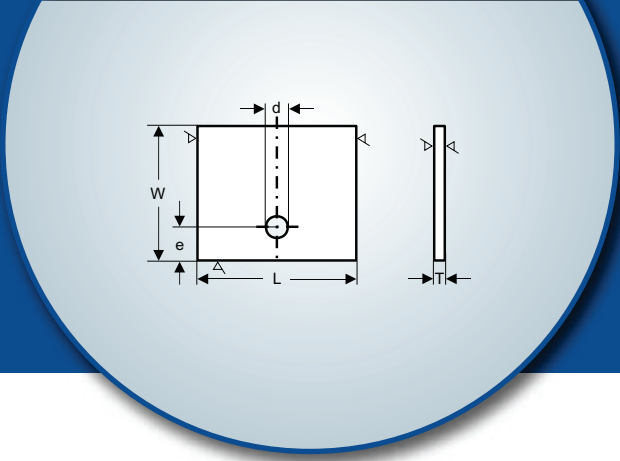

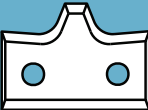



	L	W	T	d	R	T04F	T03SMG	T10MG
	mm	mm	mm	mm	mm			
	15.0	14.5	2.0	4.0	2.0	022305	033941	033942
	15.0	14.5	2.0	4.0	2.5	033939	033947	033948
	15.0	14.5	2.0	4.0	3.0	022308	033953	033954
	16.1	14.0	2.0	5.0	2.0	046693		
	16.1	14.0	2.0	5.0	3.0	049986		
	15.0	14.5	2.0	4.0	2.0	022307	033944	033945
	15.0	14.5	2.0	4.0	2.5	033940	033950	033951
	15.0	14.5	2.0	4.0	3.0	022309	033956	033957
	16.1	14.0	2.0	5.0	2.0	046694		
	16.1	14.0	2.0	5.0	3.0	049987		
	12.0	14.5	2.0	4.0	2.0	021044	033973	033974
	12.0	14.5	2.0	4.0	2.5	020397	034109	034110
	12.0	14.5	2.0	4.0	3.0	020620	034100	034101
	19.6	15.2	2.0	4.0	2.0	033963	033997	033998
	19.6	15.2	2.0	4.0	3.0	033967	034003	034004
	12.0	14.5	2.0	4.0	2.0	021045	033981	033982
	12.0	14.5	2.0	4.0	2.5	020396	034106	034107
	12.0	14.5	2.0	4.0	3.0	020619	034103	034104
	19.6	15.2	2.0	4.0	2.0	033966	034000	034001
	19.6	15.2	2.0	4.0	3.0	033968	034006	034007
	12.0	18.0	2.0	4.0	2.0	033969	034009	034010
	12.0	18.0	2.0	4.0	3.0	033970	034015	034017
IMA	12.0	18.0	2.0	4.0	2.0	034024	034037	034038
	12.0	18.0	2.0	4.0	3.0	034031	034040	034041
	12.0	18.0	2.0	4.0	2.0	033971	034012	034013
	12.0	18.0	2.0	4.0	3.0	033972	034019	034020
IMA	12.0	18.0	2.0	4.0	2.0	034025	041378	041379
	12.0	18.0	2.0	4.0	3.0	034032	040440	041381



-  Profiled standard blanks
-  Profilierte Standardblanketts
-  Plaquettes standard profilées
-  Placchette profilate standard
-  Cuchillas perfiladas standard





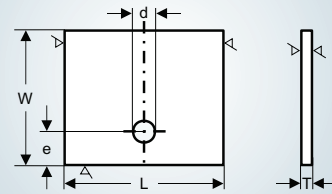

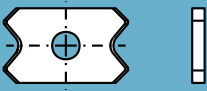
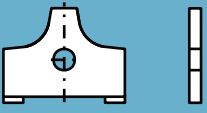
	L	W	T	d	a	R	T04F	T03SMG	T10MG
	mm	mm	mm	mm	mm	mm			
	20.8	15.0	2.0	4.0	12.0	2.0	016429	033565	033566
	20.8	15.0	2.0	4.0	12.0	3.0	016430	033568	033569
	20.8	15.0	2.0	4.0	12.0	4.0	016431	033571	033572
	30.0	17.0	2.0	4.0	20.0	5.0	016432	033574	033575
	30.0	17.0	2.0	4.0	20.0	6.0	016433	033577	033578
	30.0	17.0	2.0	4.0	20.0	7.0	016434	033580	033581
	30.0	17.0	2.0	4.0	20.0	8.0	016435	033583	033584
	30.5	16.5	2.0	3.2	20.0	5.0	016452	033595	033596
	30.5	16.5	2.0	3.2	20.0	6.0	016453	033598	033599
	30.5	16.5	2.0	3.2	20.0	7.0	016454	033601	033602
30.5	16.5	2.0	3.2	20.0	8.0	016455	033604	033605	
	20.0	16.0	2.0	3.0		3.0	033311	033607	033608
	30.0	14.0	2.0	4.0		2.0	033312	033610	033611
	30.0	14.0	2.0	4.0		2.5	033313	033613	033614
	30.0	14.0	2.0	4.0		3.0	033314	033616	033617
	20.0	16.0	2.0	3.0		3.0	033315	033619	033620
	30.0	14.0	2.0	4.0		2.0	033316	033622	033623
	30.0	14.0	2.0	4.0		2.5	033317	033625	033626
	30.0	14.0	2.0	4.0		3.0	033318	033628	033629
	12.0	12.0	1.5	4.0		45°	033319	033632	033633
	16.0	17.5	2.0	4.0		45°	032964	032965	032966
	16.0	17.5	2.0	4.4		45°	033324	041057	041058
	16.0	17.5	2.0	3.5		45°	015237	034112	034113
	21.8	19.5	2.0	3.0	12.0	10.0	033670	033674	033675
	21.8	19.5	2.0	3.0	12.0	12.0	033671	033677	033678
	21.5	20.0	2.0	3.0	12.0	9.0	016445	033657	033658
	21.5	20.0	2.0	3.0	12.0	10.0	016446	033660	033661
	21.5	20.0	2.0	3.0	12.0	11.0	016447	033663	033664
	21.5	20.0	2.0	3.0	12.0	12.0	016448	033666	033667
	21.8	19.5	2.0	3.0	12.0	10.0	033672	033680	033681
	21.8	19.5	2.0	3.0	12.0	12.0	033673	033685	033686
	21.5	20.0	2.0	3.0	12.0	9.0	016436	033645	033646
	21.5	20.0	2.0	3.0	12.0	10.0	016437	033648	033649
	21.5	20.0	2.0	3.0	12.0	11.0	016438	033651	033652
	21.5	20.0	2.0	3.0	12.0	12.0	016439	033654	033655

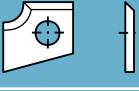
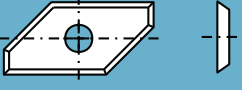
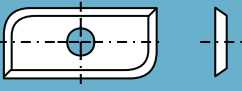
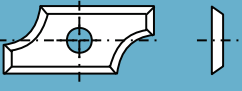
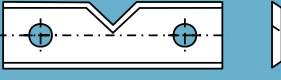

-  Profiled standard blanks
-  Profilierte Standardblanketts
-  Plaquettes standard profilées
-  Placchette profilate standard
-  Cuchillas perfiladas standard

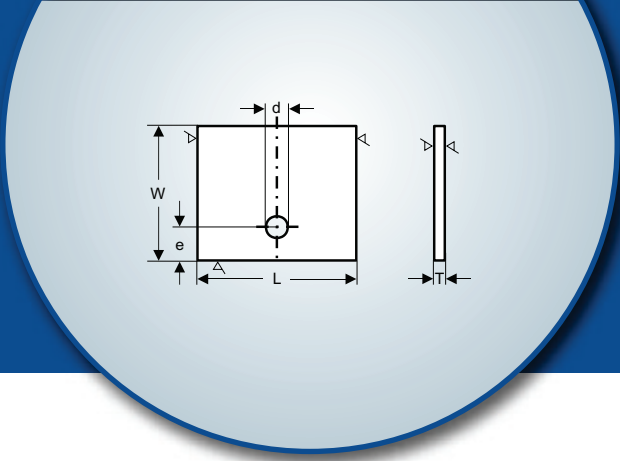

	L mm	W mm	T mm	d mm	R mm	A°	T04F	T03SMG	T06MF
	20.0	12.0	2.0	4.0	1.0	6°	032984	033031	
	20.0	12.0	2.0	4.0	1.0	15°	050309	050310	
	20.0	12.0	2.0	4.0	2.0	6°	016419	033033	
	20.0	12.0	2.0	4.0	2.0	15°	050311	050312	
	20.0	12.0	2.0	4.0	3.0	6°	016420	033034	
	20.0	12.0	2.0	4.0	3.0	15°	050313	050314	
	20.0	12.0	2.0	4.0	4.0	6°	016421	033043	
	20.0	12.0	2.0	4.0	5.0	6°	016422	033042	
	20.0	11.5	2.0	4.5	1.5		050088		
	20.0	11.5	2.0	4.5	2.0		050089		
	20.0	11.5	2.0	4.5	2.5		050090		
	20.0	11.5	2.0	4.5	3.0		050091		
	12.7	12.7	3.2		2.0				035041
	12.7	12.7	3.2		3.0				037922
	15.5	15.2	1.5	4.6	3.0		021377		
	19.5	9.0	1.5	4.0	5x45°		033086	033118	
	19.5	12.0	1.5	4.0	5x45°		034228	034229	
	19.5	9.0	1.5	4.0	5.0		033090	033128	
	19.5	12.0	1.5	4.0	5.0		034232	034233	
	19.5	9.0	1.5	4.0	2.0		033117	033142	
	19.5	9.0	1.5	4.0	3.0		033097	033146	
	19.5	9.0	1.5	4.0	4.0		033098	033149	
	19.5	9.0	1.5	4.0	5.0		033099	033152	
	19.5	12.0	1.5	4.0	2.0		034236	034240	
	19.5	12.0	1.5	4.0	3.0		034237	034243	
	19.5	12.0	1.5	4.0	4.0		034238	034246	
	19.5	12.0	1.5	4.0	5.0		034239	034249	
	39.5	12.0	1.5	4.0			033400	033401	

-  Profiled standard blanks
-  Profilierte Standardblanketts
-  Plaquettes standard profilées
-  Placchette profilate standard
-  Cuchillas perfiladas standard

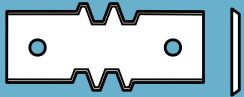

	L mm	W mm	T mm	d mm	a mm	R mm	T04F
	50.0	21.6	2.0	4.1	26.0		035810
	30.0	22.5	3.0				020272
	55.0	25.0	3.0				020502
	30.0	22.5	3.0				020273
	55.0	25.0	3.0				020503

Oertli System*	L mm	W mm	T mm	Type	T04F	T10MG
	20.0	13.5	2.0	TW32-R2	033429	033430
	20.0	13.5	2.0	TW32-R3	033427	033428
	20.0	13.5	2.0	TW32-R4	033431	033432
	20.0	13.5	2.0	TW32-R5	033433	033434
	20.0	13.5	2.0	TW32-R6	033435	033436
	29.0	16.5	2.5	TW32-R7	033437	033438
	29.0	16.5	2.5	TW32-R8	033439	033440
	29.0	16.5	2.5	TW32-R9	033441	033442
	29.0	16.5	2.5	TW32-R10	033443	033444
	40.0	21.0	2.5	TW32-R11	033445	033446
	40.0	21.0	2.5	TW32-R11.5	033447	033448
	40.0	21.0	2.5	TW32-R12	033449	033450
	40.0	21.0	2.5	TW32-R13	033451	033452
	40.0	21.0	2.5	TW32-R14	033453	033454
	40.0	21.0	2.5	TW32-R15	033455	033456

* For use in Oertli-cutterheads only

* Nur zur Verwendung in Messerköpfen der Firma Oertli

* Utilisation limitée aux porte outils de l'entreprise Oertli

* Da usare solo su teste portacottelli della Oertli

* Sólo para empleo con portacuchillas de la firma Oertli